

METRİK ERKEK TAPA (BLOK)

METRIC CLOSURE PLUG

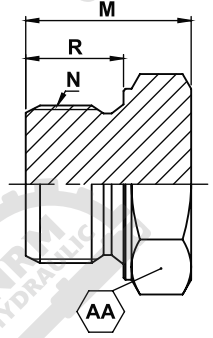

ÜRÜN KODU PART NUMBER	Diş Ölçüsü THREAD	BOYUT ÖLÇÜLERİ (MM) DIMENSIONS IN (MM)			
ID NO	N	R	M	AA	
OM1010MT	M10X1	9,5	15	14	
OM1015MT	M10X1.5	9,5	15	14	
OM1215MT	M12X1.5	11	17	17	
OM1415MT	M14X1.5	9,5	16,5	19	
OM1615MT	M16X1.5	9,5	17	22	
OM1815MT	M18X1.5	11	18	24	
OM2015MT	M20X1.5	11,5	20	24	
OM2215MT	M22X1.5	12	21	27	
OM2415MT	M24X1.5	15	26	30	
OM2615MT	M26X1.5	13,5	23,5	32	
OM3020MT	M30X2	16	27	36	
OM3620MT	M36X2	19	31	46	
OM4220MT	M42X2	19,5	34	50	
OM4520MT	M45X2	19	33,5	55	
OM5220MT	M52X2	21,5	38	60	

METRİK ERKEK TAPA (HAVŞALI)

METRIC COUNTERSINK CLOSURE PLUG

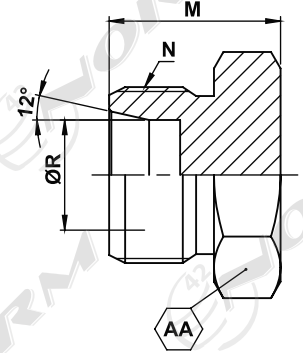

ÜRÜN KODU PART NUMBER	DIŞ ÖLÇÜSÜ THREAD	BOYUT ÖLÇÜLERİ (MM) DIMENSIONS IN (MM)		
ID NO	N	ØR	M	AA
OM1215MTL	M 12 X 1,5	6L	17	17
OM1415MTL	M 14 X 1,5	8L	17	19
OM1615MTL	M 16 X 1,5	10L	17	22
OM1815MTL	M 18 X 1,5	12L	18	24
OM2215MTL	M 22 X 1,5	15L	21	27
OM2615MTL	M 26 X 1,5	18L	23,5	27
OM3020MTL	M 30 X 2	22L	24	32
OM3620MTL	M 36 X 2	28L	25	41
OM4520MTL	M 45 X 2	35L	33,5	46
OM5220MTL	M 52 X 2	42L	34	55
OM2015MTS	M 20 X 1,5	12S	20	24
OM2415MTS	M 24 X 1,5	16S	26	30
OM3020MTS	M 30 X 2	20S	27	32
OM3620MTS	M 36 X 2	25S	30,5	41
OM4220MTS	M 42 X 2	30S	33,5	46
OM5220MTS	M 52 X 2	38S	38	55

METRİK SOMUNLU TAPA (O-RING)

PLUG WITH METRIC NUT (O-RING)

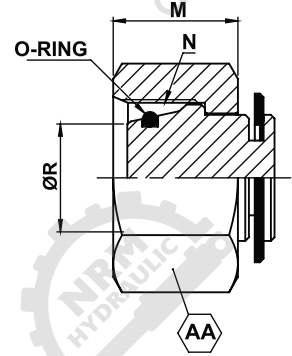

ÜRÜN KODU PART NUMBER	Diş Ölçüsü THREAD	BOYUT ÖLÇÜLERİ (MM) DIMENSIONS IN (MM)			
ID NO	N	ØR	M	AA	O-RING
OM1215SKTLO	M 12 X 1,5	6L	14	14	4X1,5
OM1415SKTLO	M 14 X 1,5	8L	13,5	17	6X1,5
OM1615SKTLO	M 16 X 1,5	10L	14	19	7,5X1,5
OM1815SKTLO	M 18 X 1,5	12L	15	22	9X1,5
OM2215SKTLO	M 22 X 1,5	15L	16	27	12X2
OM2615SKTLO	M 26 X 1,5	18L	16	32	15X2
OM3020SKTLO	M 30 X 2	22L	18	36	18X2
OM3620SKTLO	M 36 X 2	28L	17	41	25X2
OM4520SKTLO	M 45 X 2	35L	32	50	30X2,5
OM5220SKTLO	M 52 X 2	42L	21,5	60	38X2,5
OM2015SKTSO	M 20 X 1,5	12S	14	24	9X1,5
OM2415SKTSO	M 24 X 1,5	16S	16,5	30	12X2
OM3020SKTSO	M 30 X 2	20S	19,5	36	16X2,5
OM3620SKTSO	M 36 X 2	25S	33	46	20X2,5
OM4220SKTSO	M 42 X 2	30S	33	50	25X2,5
OM5220SKTSO	M 52 X 2	38S	28	60	33X2,5

METRİK SOMUNLU TAPA

NUT PLUGS

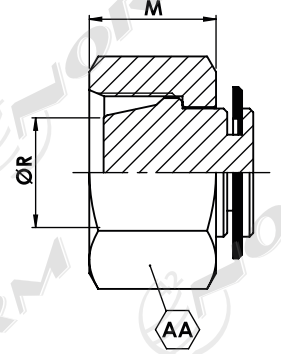

ÜRÜN KODU PART NUMBER	DIŞ ÖLÇÜSÜ THREAD	BOYUT ÖLÇÜLERİ (MM) DIMENSIONS IN (MM)			
ID NO	N	ØR	M	AA	O-RING
OM1215SKTL	M 12 X 1,5	6L	14	14	4X1,5
OM1415SKTL	M 14 X 1,5	8L	13,5	17	6X1,5
OM1615SKTL	M 16 X 1,5	10L	14	19	7,5X1,5
OM1815SKTL	M 18 X 1,5	12L	15	22	9X1,5
OM2215SKTL	M 22 X 1,5	15L	16	27	12X2
OM2615SKTL	M 26 X 1,5	18L	16	32	15X2
OM3020SKTL	M 30 X 2	22L	18	36	18X2
OM3620SKTL	M 36 X 2	28L	17	41	25X2
OM4520SKTL	M 45 X 2	35L	32	50	30X2,5
OM5220SKTL	M 52 X 2	42L	21,5	60	38X2,5
OM2015SKTS	M 20 X 1,5	12S	14	24	9X1,5
OM2415SKTS	M 24 X 1,5	16S	16,5	30	12X2
OM3020SKTS	M 30 X 2	20S	19,5	36	16X2,5
OM3620SKTS	M 36 X 2	25S	33	46	20X2,5
OM4220SKTS	M 42 X 2	30S	33	50	25X2,5
OM5220SKTS	M 52 X 2	38S	28	60	33X2,5

METRİK ALYAN BAŞLI TAPA

METRIC ALLEN HEX HEAD PLUGS

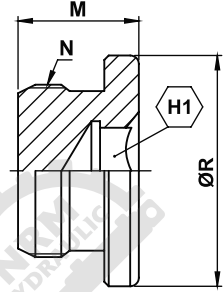

ÜRÜN KODU PART NUMBER	Diş Ölçüsü THREAD	BOYUT ÖLÇÜLERİ (MM) DIMENSIONS IN (MM)			
ID NO	N	ØR	M	H1	
OM1015MTA	M10X1.5	14	12,5	5	
OM1215MTA	M12X1.5	17	17,5	6	
OM1415MTA	M14X1.5	19	17,5	6	
OM1615MTA	M16X1.5	22	17,5	8	
OM1815MTA	M18X1.5	24	17,5	8	
OM2015MTA	M20X1.5	26	19,5	10	
OM2215MTA	M22X1.5	27	19,5	10	
OM2415MTA	M24X1.5	30	22	12	
OM2615MTA	M26X1.5	34	22	12	
OM3020MTA	M30X2	36	25	14	
OM3620MTA	M36X2	40	27	17	

METRİK PUL YATAKLI TAPA

METRIC SPOT FACE PLUGS

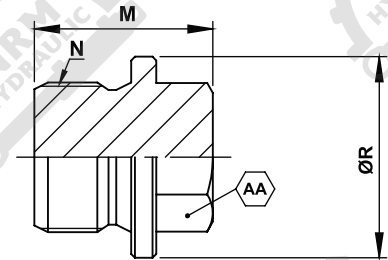

ÜRÜN KODU PART NUMBER	Diş Ölçüsü THREAD	BOYUT ÖLÇÜLERİ (MM) DIMENSIONS IN (MM)		
ID NO	N	ØR	M	AA
OM1015MPYT	M10X1.5	17,8	24	14
OM1215MPYT	M12X1.5	18	24	14
OM1415MPYT	M14X1.5	22	32	17
OM1615MPYT	M16X1.5	22	24	17
OM1815MPYT	M18X1.5	26,6	25	17
OM2015MPYT	M20X1.5	26,8	25,5	17
OM2215MPYT	M22X1.5	30	25,8	22
OM2415MPYT	M24X1.5	30	25,8	22
OM2615MPYT	M26X1.5	34	29	32

BSP ERKEK TAPA BLOK

BSP CLOSURE PLUG

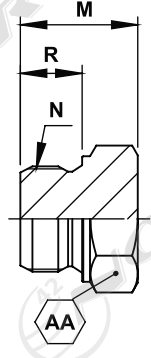

ÜRÜN KODU PART NUMBER	DIŞ ÖLÇÜSÜ THREAD	BOYUT ÖLÇÜLERİ (MM) DIMENSIONS IN (MM)		
ID NO	N	R	M	AA
OM0180RT	R 1/8-28	8	14	14
OM0140RT	R 1/4-19	12	21	19
OM0380RT	R 3/8-19	12	19,5	22
OM0120RT	R 1/2-14	14	25	27
OM0580RT	R 5/8-14	16	27	27
OM0340RT	R 3/4-14	16	27	32
OM0100RT	R 1"-11	18,5	31,5	41
OM0114RT	R 1"1/4-11	20	36,5	50
OM0112RT	R 1"1/2-11	23	38	55
OM0200RT	R 2"-11	24,5	41,5	70

BSP ERKEK TAPA HAVŞALI

BSP COUNTERSING CLOSURE PLUG

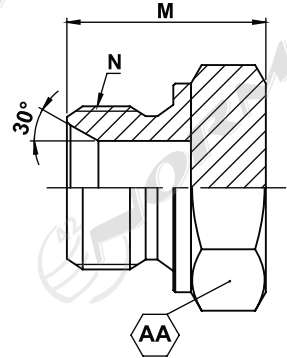

ÜRÜN KODU PART NUMBER	DIŞ ÖLÇÜSÜ THREAD	BOYUT ÖLÇÜLERİ (MM) DIMENSIONS IN (MM)		
ID NO	N	M	AA	
OM0180RTH	R 1/8-28	14	14	
OM0140RTH	R 1/4-19	17,5	19	
OM0380RTH	R 3/8-19	19	22	
OM0120RTH	R 1/2-14	23,5	27	
OM0580RTH	R 5/8-14	25,5	27	
OM0340RTH	R 3/4-14	32	32	
OM0100RTH	R 1"-11	31,5	41	
OM0114RTH	R 1"1/4-11	32	46	
OM0112RTH	R 1"1/2-11	35	50	
OM0200RTH	R 2"-11	41	70	

BSP ERKEK TAPA BLOK PERFLEX

BSP MALE PLUG PERFLEX

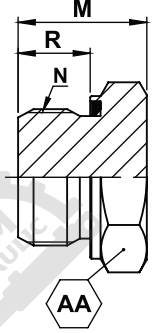

ÜRÜN KODU PART NUMBER	Diş Ölçüsü THREAD	BOYUT ÖLÇÜLERİ (MM) DIEMENSIONS IN (MM)			
ID NO	N	R	M	AA	
OM0180RTP	R 1/8-28	8	14	14	
OM0140RTP	R 1/4-19	12	21	19	
OM0380RTP	R 3/8-19	12	19,5	22	
OM0120RTP	R 1/2-14	14	25	27	
OM0580RTP	R 5/8-14	16	27	27	
OM0340RTP	R 3/4-14	16	27	32	
OM0100RTP	R 1"-11	18,5	31,5	41	
OM0114RTP	R 1 1/4-11	20	36,5	50	
OM0112RTP	R 1 1/2-11	23	38	55	
OM0200RTP	R 2"-11	24,5	41,5	70	

BSP SOMUNLU TAPA (O-RING)

BSP NUT PLUG (O-RING)

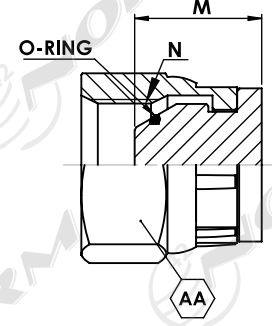

ÜRÜN KODU PART NUMBER	Diş Ölçüsü THREAD	BOYUT ÖLÇÜLERİ (MM) DIMENSIONS IN (MM)		
ID NO	N	M	AA	O-RING
OM0180KTO	1/8	9,5	14	
OM0140KTO	1/4	10	17	
OM0380KTO	3/8	12	22	
OM0120KTO	1/2	16,5	27	
OM0580KTO	5/8	16	27	
OM0340KTO	3/4	16,5	32	
OM0100KTO	1"	20	38	
OM0114KTO	1"1/4	21	50	
OM0112KTO	1"1/2	23,5	55	
OM0200KTO	2"	45	70	

BSP SOMUNLU TAPA

BSP NUT PLUG

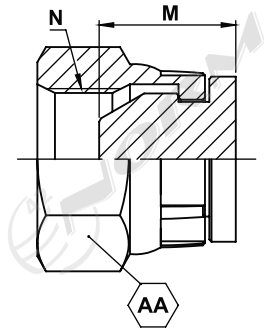

ÜRÜN KODU PART NUMBER	Diş Ölçüsü THREAD	BOYUT ÖLÇÜLERİ (MM) DIMENSIONS IN (MM)		
ID NO	N	M	AA	
OM0180KT	1/8	9,5	14	
OM0140KT	1/4	10	17	
OM0380KT	3/8	12	22	
OM0120KT	1/2	16,5	27	
OM0580KT	5/8	16	27	
OM0340KT	3/4	16,5	32	
OM0100KT	1"	20	38	
OM0114KT	1"1/4	21	50	
OM0112KT	1"1/2	23,5	55	
OM0200KT	2"	45	70	

BSP ALYAN BAŞLI TAPA (PERFLEX)

BSP HEAD HEAD PLUG (PERFLEX)

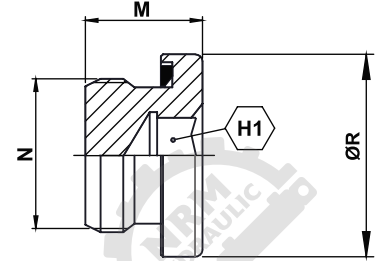

ÜRÜN KODU PART NUMBER	Diş Ölçüsü THREAD	BOYUT ÖLÇÜLERİ (MM) DIMENSIONS IN (MM)		
ID NO	N	ØR	M	H1
OM0180ATO	R1/8-28	14	12	5
OM0140ATO	R1/4-19	18	14,5	6
OM0380ATO	R3/8-19	22	15	8
OM0120ATO	R1/2-14	27	15,5	10
OM0580ATO	R5/8-14	27	16	12
OM0340ATO	R3/4-14	32	17	12
OM0100ATO	R1"-11	40	23	17
OM0114ATO	R1"1/4-11	50	22	22
OM0112ATO	R1.1/2-11	55	23,5	24
OM0200ATO	R2"-11	72	35	32

BSP ALYAN BAŞLI TAPA

BSP ALLEN HEX HEAD PLUGS

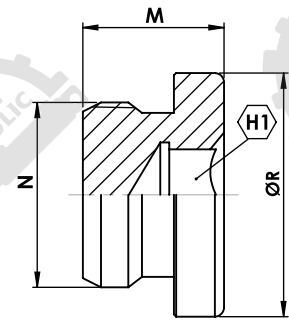

ÜRÜN KODU PART NUMBER	Diş Ölçüsü THREAD	BOYUT ÖLÇÜLERİ (MM) DIMENSIONS IN (MM)		
ID NO	N	ØR	M	H1
OM0180AT	R1/8-28	14	12	5
OM0140AT	R1/4-19	18	14,5	6
OM0380AT	R3/8-19	22	15	8
OM0120AT	R1/2-14	27	15,5	10
OM0580AT	R5/8-14	27	16	12
OM0340AT	R3/4-14	32	17	12
OM0100AT	R1"-11	40	23	17
OM0114AT	R1"1/4-11	50	22	22
OM0112AT	R1.1/2-11	55	23,5	24
OM0200AT	R2"-11	72	35	32

SETSKUR ALYAN BAŐLI TAPA

SETSKUR ALLEN HEX HEAD PLUGS

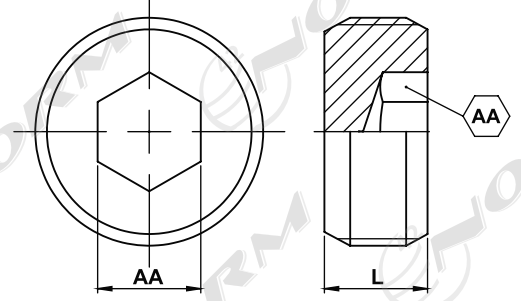

ÜRÜN KODU PART NUMBER	DIŐ ÖLÇÜŐÜ THREAD	BOYUT ÖLÇÜLERİ (MM) DIMENSIONS IN (MM)	
ID NO	N	L	AA
OM0180SA	R 1/8-28	8	5
OM0140SA	R 1/4-19	12	6
OM0380SA	R 3/8-19	12	8
OM0120SA	R 1/2-14	14	10
OM0580SA	R 5/8-14	16	12
OM0340SA	R 3/4-14	16	12
OM0100SA	R 1"-11	20	17

UNF ERKEK TAPA

UNF CLOSURE PLUG

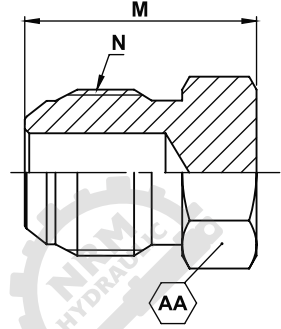

ÜRÜN KODU PART NUMBER	Diş Ölçüsü THREAD	BOYUT ÖLÇÜLERİ (MM) DIMENSIONS IN (MM)		
ID NO	N	M	AA	
OM716UT	W 7/16-20	20,5	13	
OM120UT	W 1/2-20	20,5	14	
OM916UT	W 9/16-18	21	17	
OM580UT	W 5/8-18	23,5	17	
OM340UT	W 3/4-16	27,5	19	
OM780UT	W 7/8-14	29	22	
OM1116UT	W 1"1/16-12	35	27	
OM1516UT	W 1"5/16-12	37	38	
OM1580UT	W 1"5/8-12	37	46	
OM1780UT	W 1"7/8-12	42	50	

UNF SOMUNLU TAPA

UNF NUT PLUGS

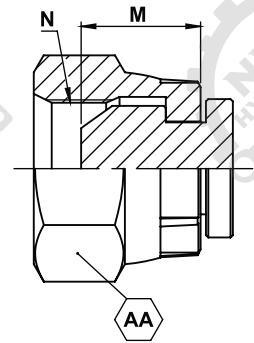

ÜRÜN KODU PART NUMBER	Diş Ölçüsü THREAD	BOYUT ÖLÇÜLERİ (MM) DIMENSIONS IN (MM)		
ID NO	N	M	AA	
OM716UST	7/16-20	19	17	
OM120UST	1/2-20	20,5	17	
OM916UST	9/16-18	21,5	19	
OM580UST	5/8-18	22	22	
OM340UST	3/4-16	24,5	24	
OM780UST	7/8-14	28	27	
OM1116UST	1"1/16-12	30,5	32	
OM1516UST	1"5/16-12	35,5	41	
OM1580UST	1"5/8-12	39	50	
OM1780UST	1"7/8-12	46	55	

UNF SOMUN TAPA

UNF COUPLINGS

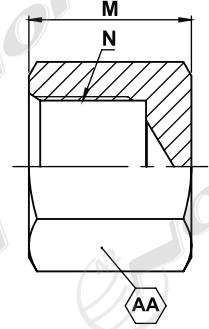

ÜRÜN KODU PART NUMBER	Diş Ölçüsü THREAD	BOYUT ÖLÇÜLERİ (MM) DIEMENSIONS IN (MM)		
ID NO	N	M	AA	
OM716USST	7/16-20	15	14	
OM120USST	1/2-20	17	17	
OM916USST	9/16-18	19	19	
OM580USST	5/8-18	20	22	
OM340USST	3/4-16	21,5	24	
OM780USST	7/8-14	25	27	
OM1116USST	1"1/16-12	27	32	
OM1516USST	1"5/16-12	26	41	
OM1580USST	1"5/8-12	27	50	
OM1780USST	1"7/8-12	30	60	

ORFS ERKEK TAPA

ORFS CLOSURE PLUG

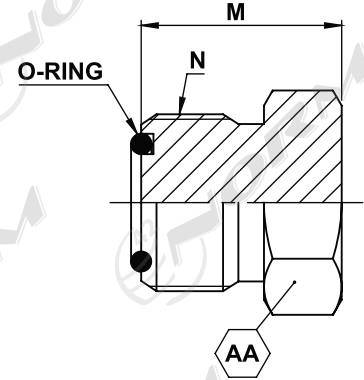

ÜRÜN KODU PART NUMBER	Diş Ölçüsü THREAD	BOYUT ÖLÇÜLERİ (MM) DIEMENSIONS IN (MM)			
ID NO	N	M	AA	O-RING	
OM916OT	9/16-18	17,7	17	7,6X1,78	
OM1116OT	11/16-16	20	19	9,2X1,78	
OM1316OT	13/16-16	22,5	22	12,4X1,78	
OM100OT	1"-14	28	27	15,6X1,78	
OM11316OT	1" 3/16-12	30,5	32	18,7X1,78	
OM1716OT	1" 7/16-12	29,5	38	23,5X1,78	
OM11116OT	1" 11/16-12	34,5	46	33X1,78	