

FLANŞLI DÜZ HORTUM RAKORLARI (SAE 3000 PSİ)

STRAIGHT FLANGES HOSE FITTINGS (SAE 3000 PSİ)

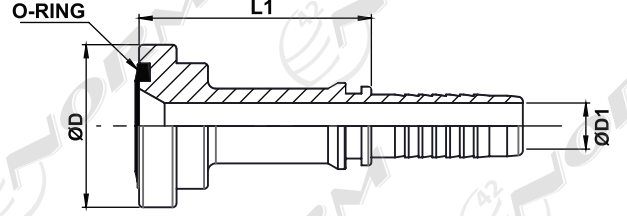

ÜRÜN KODU PART NUMBER	HORTUM İÇ ÇAPI HOSE INSIDE DIAMETER		BOYUT ÖLÇÜLERİ (MM) DIMENSIONS IN (MM)			
ID NO	SIZE	DN	ØD	L1	ØD1	O-RING
OM120302DFR3	1 / 2	12	30,2	59	9	17X3,5
OM120381DFR3	1 / 2	12	38,1	53	9	24X3,5
OM120444DFR3	1 / 2	12	44,4	55	9	32X3,5
OM580302DFR3	5 / 8	16	30,2	56	11	17X3,5
OM580381DFR3	5 / 8	16	38,1	55,5	11	24X3,5
OM580444DFR3	5 / 8	16	44,4	58	11	32X3,5
OM340381DFR3	3 / 4	20	38,1	59	14	24X3,5
OM340444DFR3	3 / 4	20	44,4	67	14	32X3,5
OM340508DFR3	3 / 4	20	50,8	68,5	14	37X3,5
OM100381DFR3	1"	25	38,1	58,5	19	24X3,5
OM100444DFR3	1"	25	44,4	62	19	32X3,5
OM100458DFR3	1"	25	50,8	69	19	37X3,5
OM100603DFR3	1"	25	60,3	71	19	46X3,2
OM114444DFR3	1" 1 / 4	32	44,4	72	24	32X3,5
OM114508DFR3	1" 1 / 4	32	50,8	72	24	37X3,5
OM114603DFR3	1" 1 / 4	32	60,3	82,5	24	46X3,5
OM114714DFR3	1" 1 / 4	32	71,4	85	24	55X3,5
OM112603DFR3	1" 1 / 2	40	60,3	89	28,5	46X3,5
OM112714DFR3	1" 1 / 2	40	71,4	88	28,5	55X3,5
OM200714DFR3	2"	50	71,4	88	42	55X3,5
OM200841DFR3	2"	50	84,1	89	42	68X3,5
OM2001016DFR3	2"	50	101,6	90	42	83X3,5

FLANŞLI 45° HORTUM RAKORLARI (SAE 3000 PSİ)

ELBOW FLANGES HOSE FITTINGS (SAE 3000 PSİ)

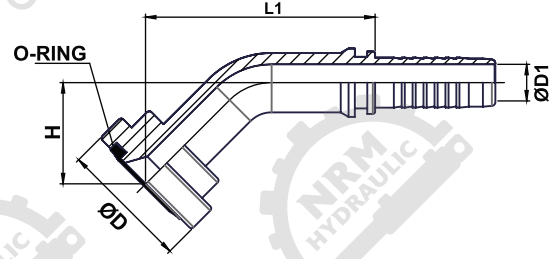

ÜRÜN KODU PART NUMBER	HORTUM İÇ ÇAP HOSE INSIDE DIAMETER		BOYUT ÖLÇÜLERİ (MM) DIMENSIONS IN (MM)				
ID NO	SIZE	DN	ØD	H	L1	ØD1	O-RING
OM12030245FR3	1 / 2	12	30,2	33	67	9	17X3,5
OM12038145FR3	1 / 2	12	38,1	33	97	9	24X3,5
OM12044445FR3	1 / 2	12	44,4	35	110	9	32X3,5
OM58030245FR3	5 / 8	16	30,2	33	85	11	17X3,5
OM58038145FR3	5 / 8	16	38,1	37	85	11	24X3,5
OM58044445FR3	5 / 8	16	44,4	41	85	11	32X3,5
OM34038145FR3	3 / 4	20	38,1	45	90	14	24X3,5
OM34044445FR3	3 / 4	20	44,4	45	70	14	32X3,5
OM34050845FR3	3 / 4	20	50,8	46	80	14	37X3,5
OM10038145FR3	1"	25	38,1	45	110	19	24X3,5
OM10044445FR3	1"	25	44,4	41	105	19	32X3,5
OM10045845FR3	1"	25	50,8	45	110	19	37X3,5
OM10060345FR3	1"	25	60,3	40	110	19	46X3,2
OM11444445FR3	1" 1 / 4	32	44,4	45	123	24	32X3,5
OM11450845FR3	1" 1 / 4	32	50,8	45	125	24	37X3,5
OM11460345FR3	1" 1 / 4	32	60,3	47	125	24	46X3,5
OM11471445FR3	1" 1 / 4	32	71,4	50	125	24	55X3,5
OM11260345FR3	1" 1 / 2	40	60,3	50	115	28,5	46X3,5
OM11271445FR3	1" 1 / 2	40	71,4	57	120	28,5	55X3,5
OM20071445FR3	2"	50	71,4	95	175	40	55X3,5
OM20084145FR3	2"	50	84,1	96	178	40	68X3,5
OM200101645FR3	2"	50	101,6	98	180	40	83X3,5

FLANŞLI 90° HORTUM RAKORLARI (SAE 3000 PSİ)

ELBOW FLANGES HOSE FITTINGS (SAE 3000 PSİ)

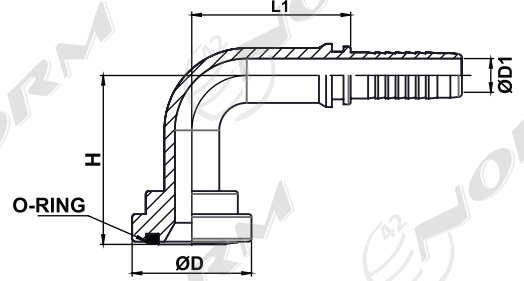

ÜRÜN KODU PART NUMBER	HORTUM İÇ ÇAPI HOSE INSIDE DIAMETER		BOYUT ÖLÇÜLERİ (MM) DIMENSIONS IN (MM)				
ID NO	SIZE	DN	ØD	H	L1	ØD1	O-RING
OM12030290FR3	1 / 2	12	30,2	49	55,5	9	17X3,5
OM12038190FR3	1 / 2	12	38,1	44	51,5	9	24X3,5
OM12044490FR3	1 / 2	12	44,4	60	55	9	32X3,5
OM58030290FR3	5 / 8	16	30,2	48	58	11	17X3,5
OM58038190FR3	5 / 8	16	38,1	63	56	11	24X3,5
OM58044490FR3	5 / 8	16	44,4	60	74	11	32X3,5
OM34038190FR3	3 / 4	20	38,1	63,5	63,5	14	24X3,5
OM34044490FR3	3 / 4	20	44,4	60	74	14	32X3,5
OM34050890FR3	3 / 4	20	50,8	60,5	62	14	37X3,5
OM10038190FR3	1"	25	38,1	72	68	19	24X3,5
OM10044490FR3	1"	25	44,4	69,5	85,5	19	32X3,5
OM10045890FR3	1"	25	50,8	71	78,5	19	37X3,5
OM10060390FR3	1"	25	60,3	85	88	19	46X3,2
OM11444490FR3	1" 1 / 4	32	44,4	78,5	82	24	32X3,5
OM11450890FR3	1" 1 / 4	32	50,8	78,5	80	24	37X3,5
OM11460390FR3	1" 1 / 4	32	60,3	75	83	24	46X3,5
OM11471490FR3	1" 1 / 4	32	71,4	88	75	24	55X3,5
OM11260390FR3	1" 1 / 2	40	60,3	98	98	28,5	46X3,5
OM11271490FR3	1" 1 / 2	40	71,4	95,5	95,5	28,5	55X3,5
OM20071490FR3	2"	50	71,4	112	147	42	55X3,5
OM20084190FR3	2"	50	84,1	120	130	42	68X3,5
OM200101690FR3	2"R	50	101,6	130	148	42	83X3,5

FLANŞLI DÜZ HORTUM RAKORLARI (SAE 6000 PSİ)

STRAIGHT FLANGES HOSE FITTINGS (SAE 6000 PSİ)

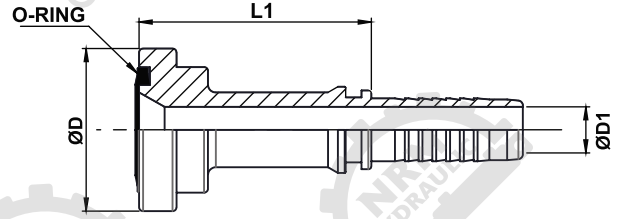

ÜRÜN KODU PART NUMBER	HORTUM İÇ ÇAP HOSE INSIDE DIAMETER		BOYUT ÖLÇÜLERİ (MM) DIMENSIONS IN (MM)			
ID NO	SIZE	DN	ØD	L1	ØD1	O-RING
OM120318DFR6	1 / 2	12	31,8	59	9	17X3,5
OM120341DFR6	1 / 2	12	34,1	56	9	18X3,5
OM120413DFR6	1 / 2	12	41,3	60	9	25X3,5
OM580318DFR6	5 / 8	16	31,8	56	11	17X3,5
OM580341DFR6	5 / 8	16	34,1	56	11	18X3,5
OM580413DFR6	5 / 8	16	41,3	56	11	25X3,5
OM340413DFR6	3 / 4	20	41,3	64	14	25X3,5
OM340476DFR6	3 / 4	20	47,6	69	14	32X3,5
OM340540DFR6	3 / 4	20	54	72	14	37X3,5
OM100413DFR6	1"	25	41,3	63	19	25X3,5
OM100476DFR6	1"	25	47,6	75	19	32X3,5
OM100540DFR6	1"	25	54	68	19	37X3,5
OM114476DFR6	1" 1 / 4	32	47,6	73	24	32X3,5
OM114540DFR6	1" 1 / 4	32	54	85	24	37X3,5
OM114630DFR6	1" 1 / 4	32	63	83	24	46X3,5
OM112540DFR6	1" 1 / 2	40	54	84	28,5	37X3,5
OM112630DFR6	1" 1 / 2	40	63	86,5	28,5	46X3,5
OM112794DFR6	1" 1 / 2	40	79,4	88	28,5	55X3,5
OM200630DFR6	2"	50	63	92	42	46X3,5
OM200794DFR6	2"	50	79,4	95,5	42	55X3,5

FLANŞLI 45° HORTUM RAKORLARI (SAE 6000 PSİ)

ELBOW FLANGES HOSE FITTINGS (SAE 6000 PSİ)

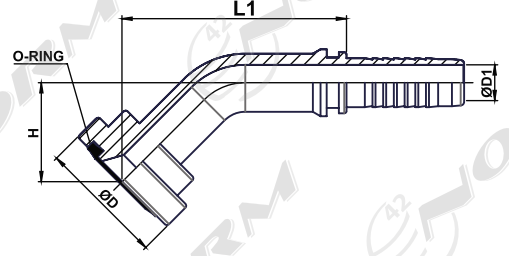

ÜRÜN KODU PART NUMBER	HORTUM İÇ ÇAP HOSE INSIDE DIAMETER		BOYUT ÖLÇÜLERİ (MM) DIMENSIONS IN (MM)				
ID NO	SIZE	DN	ØD	H	L1	ØD1	O-RING
OM12031845FR6	1 / 2	12	31,8	30	65	9	17X3,5
OM12034145FR6	1 / 2	12	34,1	30	65	9	18X3,5
OM12041345FR6	1 / 2	12	41,3	33	70	9	25X3,5
OM58031845FR6	5 / 8	16	31,8	37	75	11	17X3,5
OM58034145FR6	5 / 8	16	34,1	37	75	11	18X3,5
OM58041345FR6	5 / 8	16	41,3	37	75	11	25X3,5
OM34041345FR6	3 / 4	20	41,3	33	78	14	25X3,5
OM34047645FR6	3 / 4	20	47,6	33	72	14	32X3,5
OM34054045FR6	3 / 4	20	54	35	70	14	37X3,5
OM10041345FR6	1"	25	41,3	31	90	19	25X3,5
OM10047645FR6	1"	25	47,6	31	80	19	32X3,5
OM10054045FR6	1"	25	54	30	86	19	37X3,5
OM11447645FR6	1" 1 / 4	32	47,6	44	98	24	32X3,5
OM11454045FR6	1" 1 / 4	32	54	32	92	24	37X3,5
OM11463045FR6	1" 1 / 4	32	63	37,5	101	24	46X3,5
OM11254045FR6	1" 1 / 2	40	54	41	110	28,5	37X3,5
OM11263045FR6	1" 1 / 2	40	63	46,5	115	28,5	46X3,5
OM11279445FR6	1" 1 / 2	40	79,4	48	120	28,5	55X3,5
OM20063045FR6	2"	50	63	45	125	42	46X3,5
OM20079445FR6	2"	50	79,4	41,5	128	42	55X3,5

FLANŞLI 90° HORTUM RAKORLARI (SAE 6000 PSİ)

ELBOW FLANGES HOSE FITTINGS (SAE 6000 PSİ)

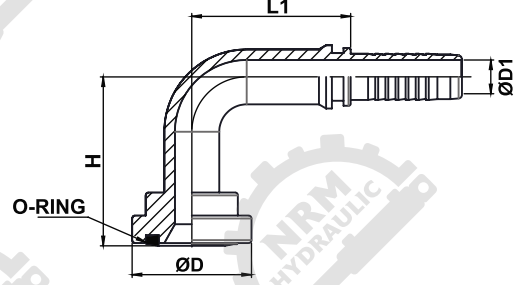

ÜRÜN KODU PART NUMBER	HORTUM İÇ ÇAP HOSE INSIDE DIAMETER		BOYUT ÖLÇÜLERİ (MM) DIMENSIONS IN (MM)				
ID NO	SIZE	DN	ØD	H	L1	ØD1	O-RING
OM12031890FR6	1 / 2	12	31,8	49	47	9	17X3,5
OM12034190FR6	1 / 2	12	34,1	48	48	9	18X3,5
OM12041390FR6	1 / 2	12	41,3	60	53	9	25X3,5
OM58031890FR6	5 / 8	16	31,8	48	59,5	11	17X3,5
OM58034190FR6	5 / 8	16	34,1	65	55	11	18X3,5
OM58041390FR6	5 / 8	16	41,3	65	55	11	25X3,5
OM34041390FR6	3 / 4	20	41,3	59,5	61	14	25X3,5
OM34047690FR6	3 / 4	20	47,6	66	58,5	14	32X3,5
OM34054090FR6	3 / 4	20	54	70	60	14	37X3,5
OM10041390FR6	1"	25	41,3	71,5	77	19	25X3,5
OM10047690FR6	1"	25	47,6	75	85	19	32X3,5
OM10054090FR6	1"	25	54	71,5	68	19	37X3,5
OM11447690FR6	1" 1 / 4	32	47,6	78	80,5	24	32X3,5
OM11454090FR6	1" 1 / 4	32	54	83,5	89	24	37X3,5
OM11463090FR6	1" 1 / 4	32	63	81	90,5	24	46X3,5
OM11254090FR6	1" 1 / 2	40	54	90	106	28,5	37X3,5
OM11263090FR6	1" 1 / 2	40	63	91,5	100,5	28,5	46X3,5
OM11279490FR6	1" 1 / 2	40	79,4	35	101	28,5	55X3,5
OM20063090FR6	2"	50	63	120	125	42	46X3,5
OM20079490FR6	2"	50	79,4	120	137	42	55X3,5

FLANŞLI KALIN DÜZ HORTUM RAKORLARI (SAE 6000 PSİ)

STRAIGHT FLANGES HOSE FITTINGS (SAE 6000 PSİ)

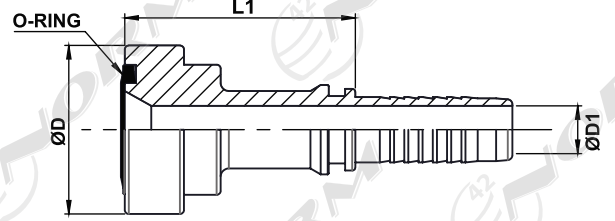

ÜRÜN KODU PART NUMBER	HORTUM İÇ ÇAPI HOSE INSIDE DIAMETER		BOYUT ÖLÇÜLERİ (MM) DIMENSIONS IN (MM)			
ID NO	SIZE	DN	ØD	L1	ØD1	O-RING
OM120413DFR6K	1 / 2	12	41,3	60	9	24X4,5
OM580413DFR6K	5 / 8	16	41,3	56	11	24X4,5
OM340413DFR6K	3 / 4	20	41,3	64	14	24X4,5
OM340476DFR6K	3 / 4	20	47,6	69	14	28,5X4,5
OM340540DFR6K	3 / 4	20	54	72	14	36X4,5
OM100413DFR6K	1"	25	41,3	63	19	24X4,5
OM100444DFR6K	1"	25	44,4	69	19	25X4,5
OM100476DFR6K	1"	25	47,6	75	19	28,5X4,5
OM100540DFR6K	1"	25	54	68	19	36X4,5
OM100635DFR6K	1"	25	63	71	19	42X4,5
OM114476DFR6K	1" 1 / 4	32	47,6	73	24	28,5X4,5
OM114540DFR6K	1" 1 / 4	32	54	85	24	36X4,5
OM114635DFR6K	1" 1 / 4	32	63	83	24	42X4,5
OM112540DFR6K	1" 1 / 2	40	54	84	28,5	36X4,5
OM112635DFR6K	1" 1 / 2	40	63	86,5	28,5	36X4,5

FLANŞLI KALIN 45° HORTUM RAKORLARI (SAE 6000 PSİ)

ELBOW FLANGES HOSE FITTINGS (SAE 6000 PSI)

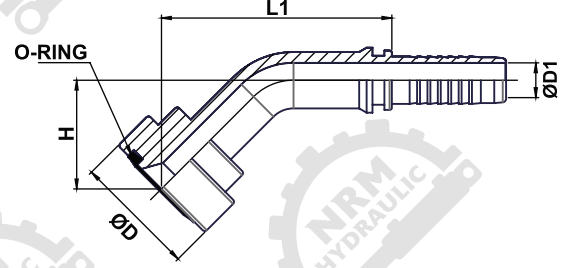

ÜRÜN KODU PART NUMBER	HORTUM İÇ ÇAPI HOSE INSIDE DIAMETER		BOYUT ÖLÇÜLERİ (MM) DIMENSIONS IN (MM)				
ID NO	SIZE	DN	ØD	H	L1	ØD1	O-RING
OM12041345FR6K	1 / 2	12	41,3	33	70	9	24X4,5
OM58041345FR6K	5 / 8	16	41,3	37	75	11	24X4,5
OM34041345FR6K	3 / 4	20	41,3	33	78	14	24X4,5
OM34047645FR6K	3 / 4	20	47,6	33	72	14	28,5X4,5
OM34054045FR6K	3 / 4	20	54	35	70	14	36X4,5
OM10041345FR6K	1"	25	41,3	31	90	19	24X4,5
OM10044445FR6K	1"	25	44,4	31	90	19	25X4,5
OM10047645FR6K	1"	25	47,6	31	80	19	28,5X4,5
OM10054045FR6K	1"	25	54	30	86	19	36X4,5
OM10063545FR6K	1"	25	63	37,5	86	19	42X4,5
OM11447645FR6K	1" 1 / 4	32	47,6	44	98	24	28,5X4,5
OM11454045FR6K	1" 1 / 4	32	54	32	92	24	36X4,5
OM11463545FR6K	1" 1 / 4	32	63	37,5	101	24	42X4,5
OM11254045FR6K	1" 1 / 2	40	54	41	110	28,5	36X4,5
OM11263545FR6K	1" 1 / 2	40	63,5	46,5	115	28,5	36X4,5

FLANŞLI KALIN 90° HORTUM RAKORLARI (SAE 6000 PSİ)

ELBOW FLANGES HOSE FITTINGS(SAE 6000 PSİ)

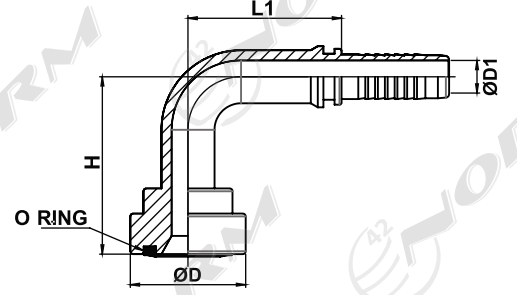

ÜRÜN KODU PART NUMBER	HORTUM İÇ ÇAPI HOSE INSIDE DIAMETER		BOYUT ÖLÇÜLERİ (MM) DIMENSIONS IN (MM)				
ID NO	SIZE	DN	ØD	H	L1	ØD1	O-RING
OM12041390FR6K	1 / 2	12	41,3	63	50	9	24X4,5
OM58041390FR6K	5 / 8	16	41,3	68	52	11	24X4,5
OM34041390FR6K	3 / 4	20	41,3	65	66	14	24X4,5
OM34047690FR6K	3 / 4	20	47,6	69	62	14	28,5X4,5
OM34054090FR6K	3 / 4	20	54	67	75	14	36X4,5
OM10041390FR6K	1"	25	41,3	80	88	19	24X4,5
OM10044490FR6K	1"	25	44,4	77	80	19	25X4,5
OM10047690FR6K	1"	25	47,6	75	79,5	19	28,5X4,5
OM10054090FR6K	1"	25	54	75,5	79	19	36X4,5
OM10063590FR6K	1"	25	63	81	79	19	42X4,5
OM11447690FR6K	1" 1 / 4	32	47,6	88	98	24	28,5X4,5
OM11454090FR6K	1" 1 / 4	32	54	80,5	97	24	36X4,5
OM11463590FR6K	1" 1 / 4	32	63	90	98	24	42X4,5
OM11254090FR6K	1" 1 / 2	40	54	92	98	28,5	36X4,5
OM11263590FR6K	1" 1 / 2	40	63,5	98	98	28,5	36X4,5

FLANŞLI METRİK ADAPTÖR RAKORLARI

METRIC THREAD FLANGES ADOPTER FITTINGS

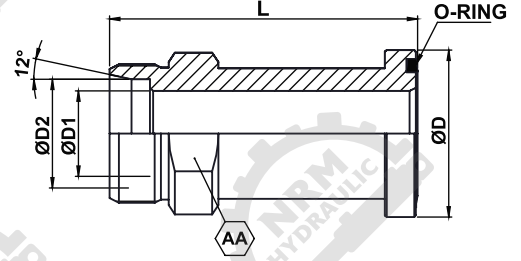

ÜRÜN KODU PART NUMBER	FLANŞ ÇAPI FLANGE DIAMETER	DIŞ ÖLÇÜSÜ THREAD	BOYUT ÖLÇÜLERİ (MM) DIEMENSIONS IN (MM)				
ID NO	ØD	N	ØD1	ØD2	L	AA	O-RING
OM422444FA	44,4 mm	M42X2	24	30	95	46	32X3,5
OM422476FA	47,6 mm	M42X2	24	30	96	46	32X3,5
OM42250FA	50,8 mm	M42X2	25	30	100	46	37X3,5
OM42254FA	54 mm	M42X2	28	30	98	46	37X3,5
OM452444FA	44,4 mm	M45X2	24	35	100	46	32X3,5
OM52508FA	50,8 mm	M45X2	25	35	102	46	37X3,5
OM52254FA	54 mm	M52X2-38S	28	38	105	55	37X3,5
OM522635FA	63,5 mm	M52X2-38S	28	38	106	55	46X3,5
OM422476FAL	47,6 mm	M42X2	24	30	110	46	32X3,5
OM45248FA	48 mm	M45X2	24	35	106	46	32X3,5
OM45254FA	54 mm	M45X2	28	35	108	46	37X3,5

FLANŞLI BSP ADAPTÖR RAKORLARI

BSP THREAD FLANGES ADOPTER FITTINGS

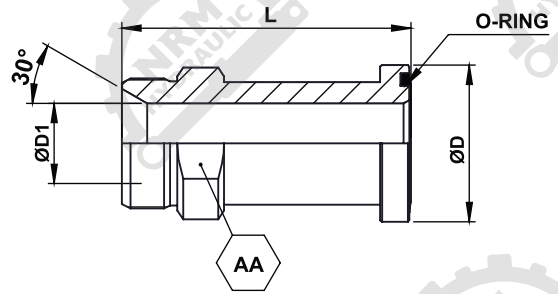

ÜRÜN KODU PART NUMBER	FLANŞ ÇAPI FLANGE DIAMETER	DIŞ ÖLÇÜSÜ THREAD	BOYUT ÖLÇÜLERİ (MM) DIEMENSIONS IN (MM)				
ID NO	ØD	N	ØD1	L	AA	O-RING	
OM10054FA	54 mm	R 1"-11	28	95	41	37X3,5	

FLANŞLI ORSF ADAPTÖR RAKORLARI

ORFS THREAD FLANGES ADOPTER FITTINGS

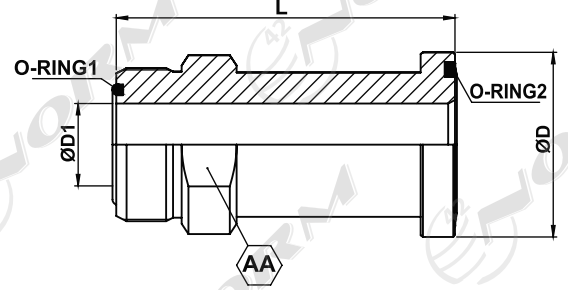

ÜRÜN KODU PART NUMBER	FLANŞ ÇAPI FLANGE DIAMETER	DIŞ ÖLÇÜSÜ THREAD	BOYUT ÖLÇÜLERİ (MM) DIEMENSIONS IN (MM)				
ID NO	ØD	N	ØD1	L	AA	O-RING 1	O-RING 2
OM1716444FA	44,4 mm	1" 7/16-12	24	95	38	23,7X1,78	32X3,5
OM11116444FA	44,4 mm	1" 11/16-12	24	98	46	33X1,78	32,3,5
OM1111648FA	48 mm	1" 11/16-12	24	100	46	33X1,78	32X3,5
OM11116508FA	50,8 mm	1" 11/16-12	24	102	46	33X1,78	37X3,5
OM1111654FA	54 mm	1"11/16-12	28	105	46	33X1,78	37X3,5

FLANŞLI UNF ADAPTÖR RAKORLARI

UNF THREAD FLANGES ADOPTER FITTINGS

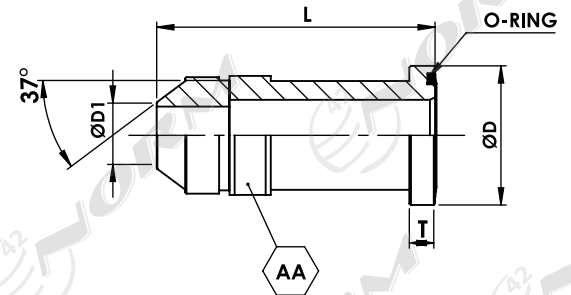

ÜRÜN KODU PART NUMBER	FLANŞ ÇAPI FLANGE DIAMETER	DIŞ ÖLÇÜSÜ THREAD	BOYUT ÖLÇÜLERİ (MM) DIEMENSIONS IN (MM)				
ID NO	ØD	N	ØD1	L	AA	O-RING	
OM15854FA	54 mm	1" 5/8-12	26	95	46	37X3,5	

FLANŞLI METRİK 90° ADAPTÖR RAKORLARI

METRIC 90° THREAD FLANGES ADOPTER FITTINGS

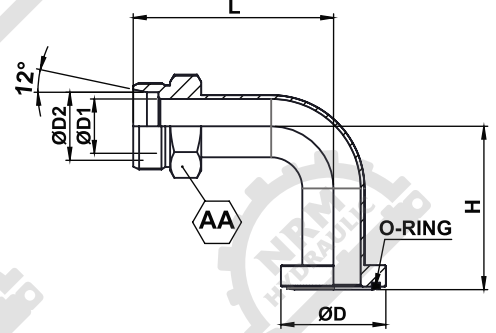

ÜRÜN KODU PART NUMBER	FLANŞ ÇAPI FLANGE DIAMETER	Diş Ölçüsü THREAD	BOYUT ÖLÇÜLERİ (MM) DIEMENSIONS IN (MM)					
ID NO	ØD	N	ØD1	ØD2	L	H	AA	O-RING
OMEF422543090FR	54 mm	M42 X 2 30S	24	30	106	90	46	37x3,5
OMEF422543590FR	54 mm	M42 X 2 35L	28	35	106	90	46	37x3,5
OMEF52250090FR	50 mm	M52 X 2 38S	28	38	80,5	78	55	32x3,5
OMEF52254090FR	54 mm	M52 X 2 38S	28	38	80,5	78	55	37x3,5
OMEF52263590FR	63,5 mm	M52 X 2 38S	42	38	125	120	55	46x3,5

FLANŞLI METRİK 45° ADAPTÖR RAKORLARI

METRIC 45° THREAD FLANGES ADOPTER FITTINGS

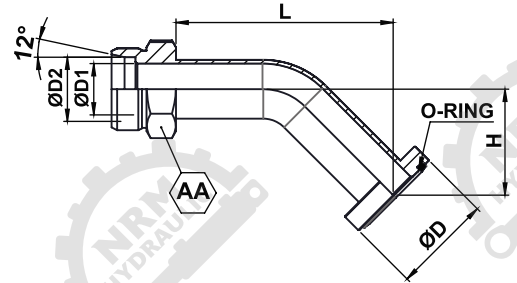

ÜRÜN KODU PART NUMBER	FLANŞ ÇAPI FLANGE DIAMETER	Diş Ölçüsü THREAD	BOYUT ÖLÇÜLERİ (MM) DIEMENSIONS IN (MM)					
ID NO	ØD	N	ØD1	ØD2	L	H	AA	O-RING
OMEF52254045FR	54 mm	M52X2 38S	28	38	110	41	55	37x3,5