

## ALÜMİNYUM KLİMA SOKETLERİ (MANUEL PRESLİ)

ALUMINUM AIR CONDITIONING SOCKETS (MANUAL PRESSED)

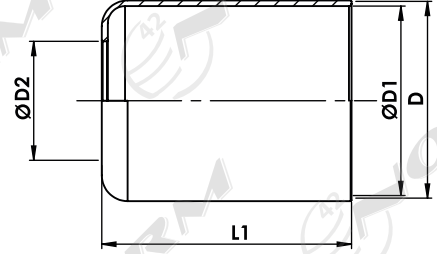

ÜRÜN KODU PART NUMBER	ÜRÜN CİNSİ PRODUCT TYPE	BOYUT ÖLÇÜLERİ (MM) DIEMENSIONS IN (MM)			
ID NO		L1	D	D1	D2
OM02000AKS	3/8"	35	23	20	10
OM02300AKS	1/2"	35	26	23	12
OM02400AKS	5/8"	35	27	24	14
OM02600AKS	3/4"	35	29	26	16
OM01600AKS	M5	35	19	16	11
OM01700AKS	M6	35	20	17	11
OM01850AKS	M7	35	21,5	18,5	13
OM02100AKS	M8	35	24	21	14
OM02200AKS1	M9	35	25	22	13
OM02450AKS	M10	35	27,5	24,5	16,5
OM02800AKS	M11	35	31	28	16
OM02900AKS	M12	35	32	29	16
OM03000AKS	M13	35	33	30	16
OM02200AKS	NS01	25	25	22	13
OM01830AKS	NS02	25	21	18,3	14
OM01650AKS	NS03	22,5	18	16,5	12,5
OM01550AKS	NS04	22	16,5	15	11,5

## ALÜMİNYUM KLİMA SOKETLERİ (HİDROLİK PRESLİ)

ALUMINUM AIR CONDITIONING SOCKETS (HYDRAULIC PRESSED)

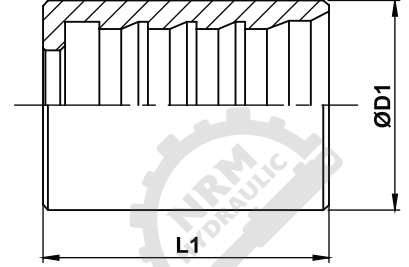

ÜRÜN KODU PART NUMBER	HORTUM İÇ ÇAPI HOSE INSIDE DIAMETER		BOYUT ÖLÇÜLERİ (MM) DIEMENSIONS IN (MM)	
ID NO	SIZE	DN	ØD1	L1
OM0516AKS	5/16	5	23	31,5
OM0380AKS	3/8	10	25	35
OM0120AKS	1/2	13	30	39,5
OM0580AKS	5/8	16	32,5	44,5

## ALÜMİNYUM KLİMA EKLER

ALUMINIUM CONNECTORS

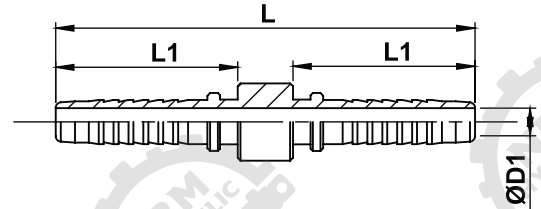

ÜRÜN KODU PART NUMBER	HORTUM İÇ ÇAPI HOSE INSIDE DIAMETER		BOYUT ÖLÇÜLERİ (MM) DIEMENSIONS IN (MM)		
ID NO	SIZE	DN	ØD1	L1	L
OM0516AHHE	5/16	8	5	33	76
OM0380AHHE	3/8	10	6,5	35	82
OM0120AHHE	1/2	12	9	38	87
OM0580AHHE	5/8	16	11	45	103,5

## ALÜMİNYUM KLİMA KAYNAKLIK EKLER

ALUMINIUM CLIMATE WELDING FITTING

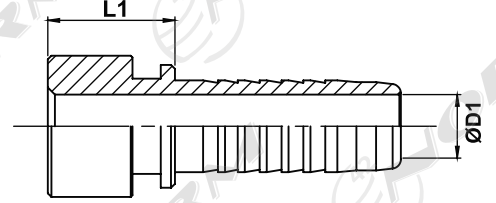

ÜRÜN KODU PART NUMBER	HORTUM İÇ ÇAPI HOSE INSIDE DIAMETER	BOYUT ÖLÇÜLERİ (MM) DIEMENSIONS IN (MM)		
ID NO	SIZE	DN	ØD1	L1
OM0516AKE	5/16	8	5	21
OM0380AKE	3/8	10	6,5	24
OM0120AKE	1/2	12	9	21
OM0580AKE	5/8	16	11	23

## DÜZ KLİMA HORTUM RAKORU

STRAIGHT CLIMATE FITTING

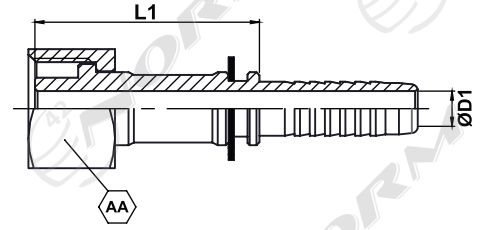

ÜRÜN KODU PART NUMBER	HORTUM İÇ ÇAPI HOSE INSIDE DIAMETER	DIŞ ÖLÇÜSÜ THREAD	BOYUT ÖLÇÜLERİ (MM) DIEMENSIONS IN (MM)			
ID NO	SIZE	N	ØD1	L1	AA	
OM516160DKR	5 / 16	8	M16X1,5	5	41	19
OM516580DKR	5 / 16	8	5/8-18	5	39	19
OM380580DKR	3 / 8	10	5 / 8-18	6,5	40,5	19
OM380340DKR	3 / 8	10	3 / 4-16	6,5	41,5	22
OM120340DKR	1 / 2	12	3 / 4-16	9	45	22
OM120780DKR	1 / 2	12	7 / 8-14	9	40	27
OM580780DKR	5 / 8	16	7 / 8-14	11	40,5	27
OM780780DKR	7 / 8	22	7 / 8-14	16,5	41,5	27

## 90° KLİMA HORTUM RAKOR

90° CLIMATE FITTINGS

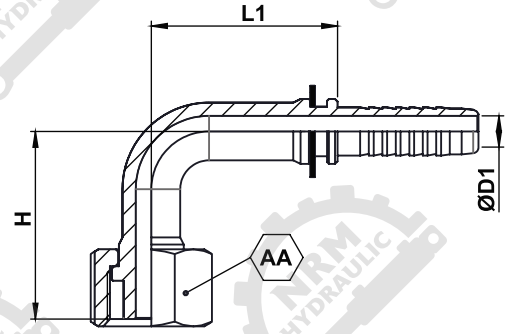

ÜRÜN KODU PART NUMBER	HORTUM İÇ ÇAP HOSE INSIDE DIAMETER		DIŞ ÖLÇÜSÜ THREAD	BOYUT ÖLÇÜLERİ (MM) DIEMENSINS IN (MM)			
ID NO	SIZE	DN	N	ØD1	L1	H	AA
OM51616090KR	5 / 16	8	M16X1,5	5	33	35	19
OM51658090KR	5 / 16	8	5/8-18	5	31	35,5	19
OM38058090KR	3 / 8	10	5 / 8-18	6,5	39,5	38,5	19
OM38034090KR	3 / 8	10	3 / 4-16	6,5	36	41	22
OM12034090KR	1 / 2	12	3 / 4-16	9	43	41,5	22
OM12078090KR	1 / 2	12	7 / 8-14	9	42	45,5	27
OM58078090KR	5 / 8	16	7 / 8-14	11	42,5	45,5	27
OM78078090KR	7 / 8	22	7 / 8-14	16,5	43,5	45,5	27

## ALÜMİNYUM KLİMA KAYNAKLIK NİPEL

ALUMINIUM WELDING UNIONS

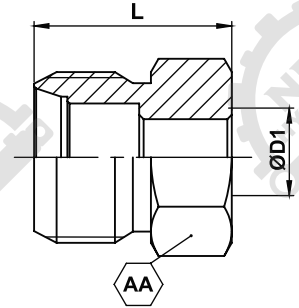

ÜRÜN KODU PART NUMBER	DIŞ ÖLÇÜSÜ THREAD	BOYUT ÖLÇÜLERİ (MM) DIEMENSINS IN (MM)		
ID NO	SIZE	ØD1	L	AA
OM0580AKN	5/8	6,5	20	17
OM0340AKN	3/4	9	24	19
OM0780AKN	7/8	11	22	28